

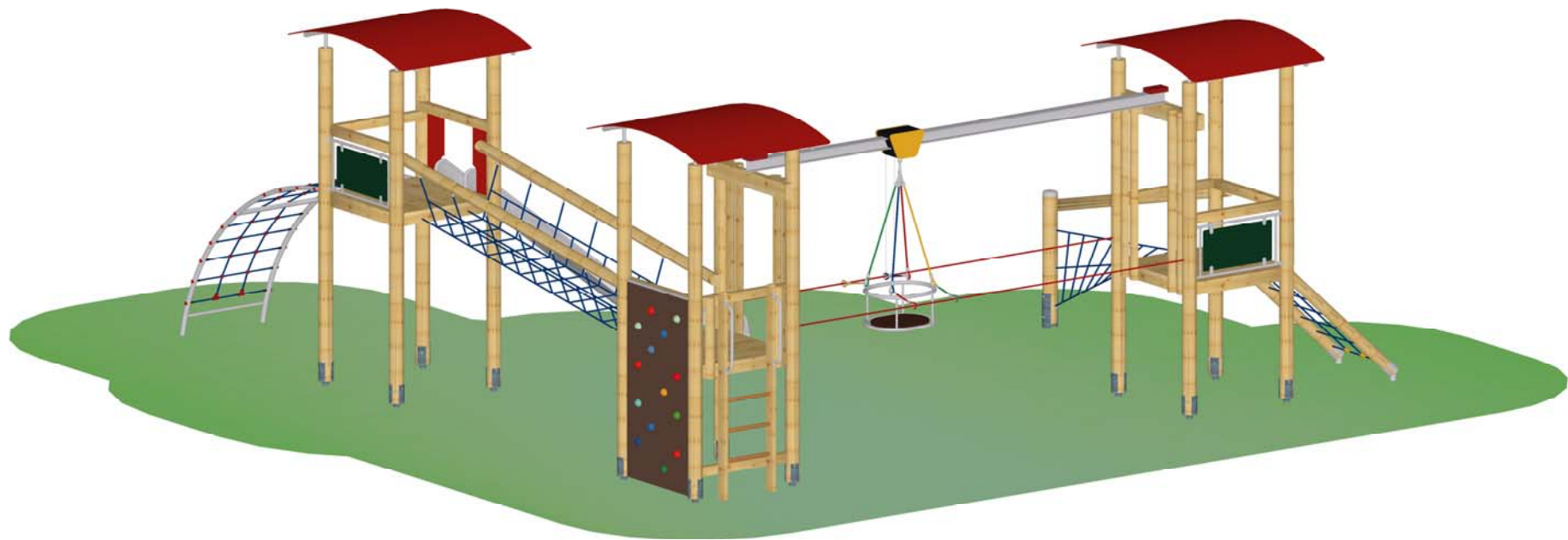

Spielkombination "Distelhausen" - Art.Nr. 31 2030 0078

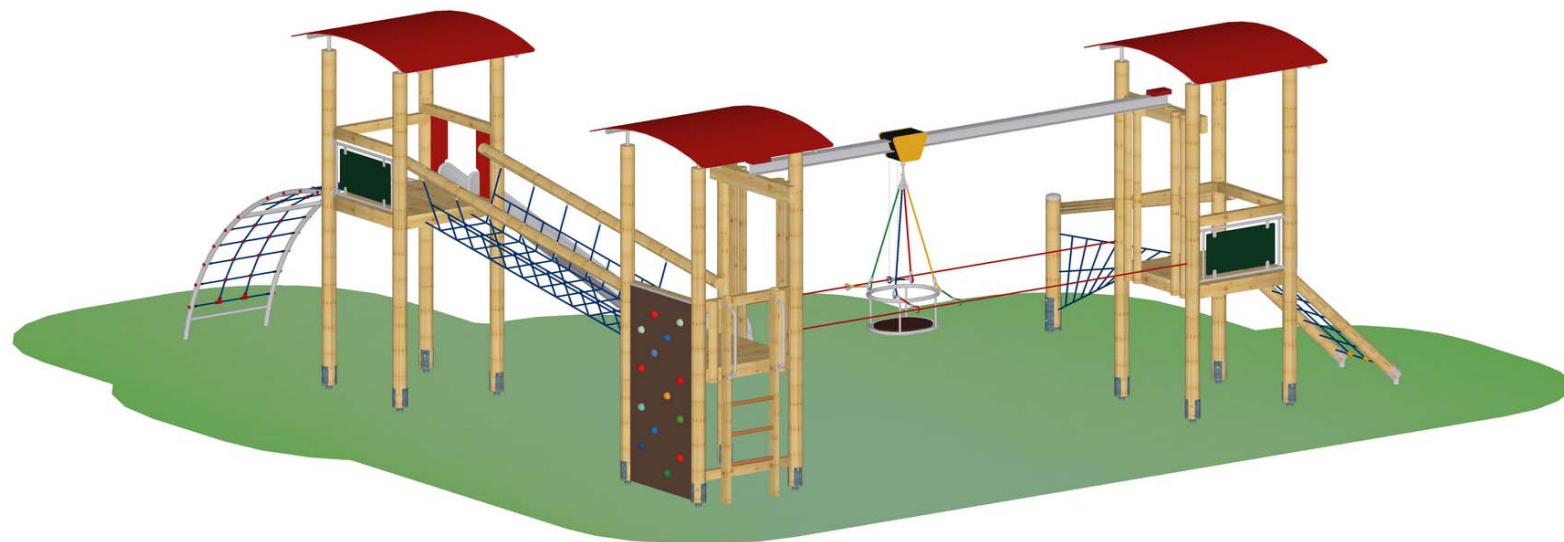



G SPK.Distelhausen  
 m Art.Nr. 31 2030 0078  
 b Fassung : 04.02.2019  
 H Konstr. : M. Knoll  
 Technische Änderungen vorbehalten  
 ☎ 09342/9649-0 📠 09342/9649-10

Gedruckt am 29.09.2020  
 Blatt 0  
 gez. :M.Knoll

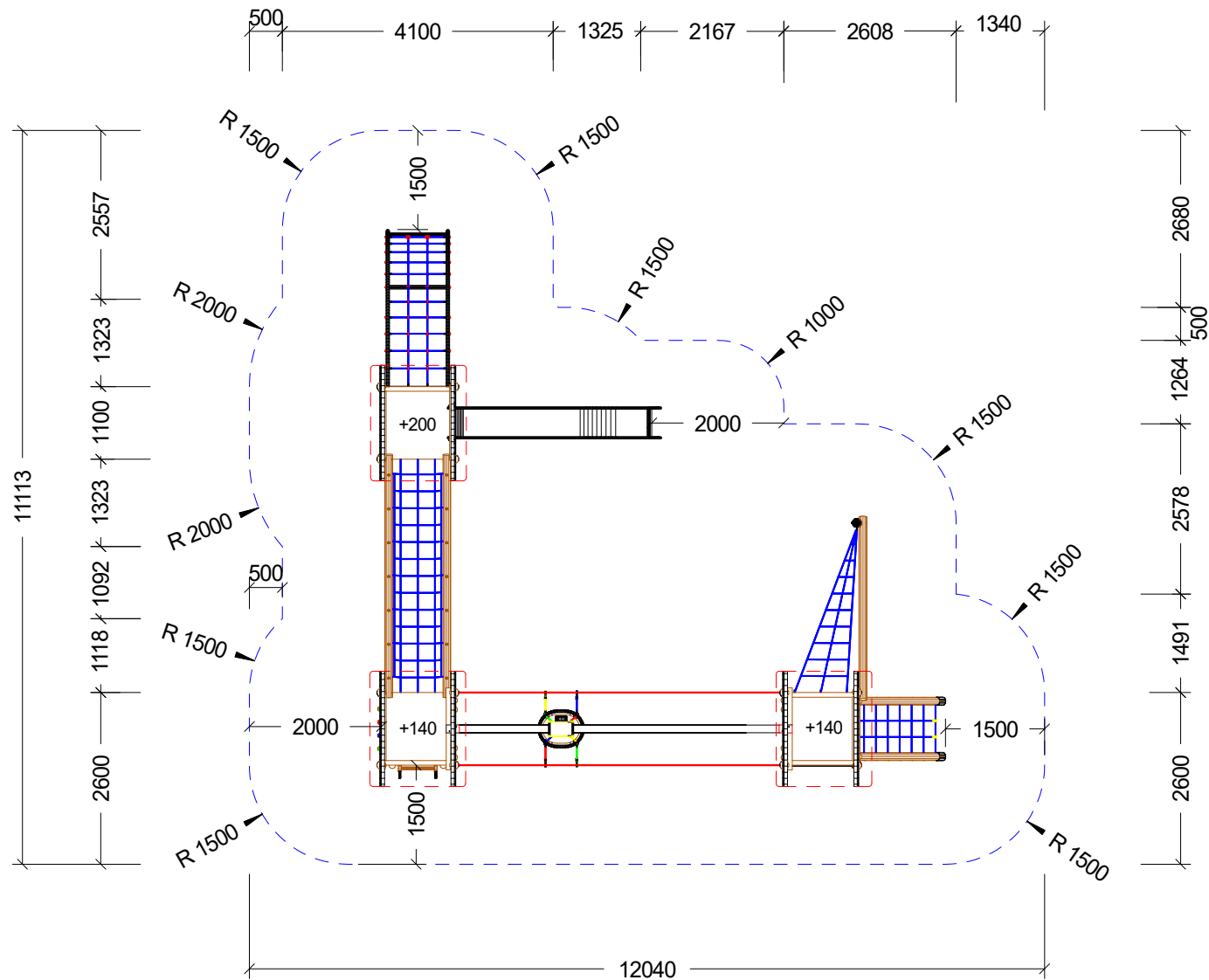

Max. Fallhöhe 2,10 m



SPK.Distelhausen  
 Art.Nr. 31 2030 0078  
 G Fassung : 01.02.2019  
 m Konstr. : M. Knoll  
 b Technische Änderungen vorbehalten  
 H  
 ☎ 09342/9649-0 📠 09342/9649-10

Gedruckt am 29.09.2020  
 M : 1 = 100 Blatt 2  
 gez. :M.Knoll

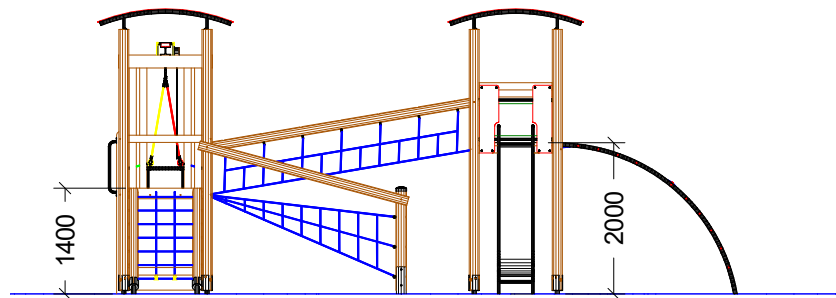
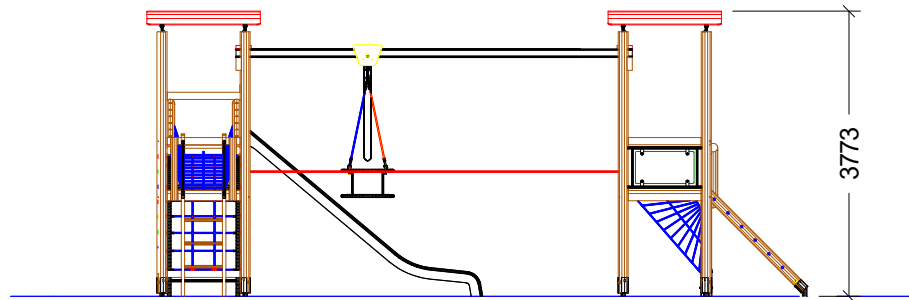

SPK.Distelhausen  
 Art.Nr. 31 2030 0078  
 G Fassung : 04.02.2019  
 m Konstr. : M. Knoll  
 b Technische Änderungen vorbehalten  
 H  
 ☎ 09342/9649-0 📠 09342/9649-10

Gedruckt am 29.09.2020  
 M : 1 = 100 Blatt 1  
 gez. :M.Knoll

# Fundament-Plan

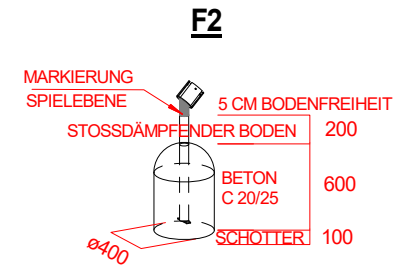
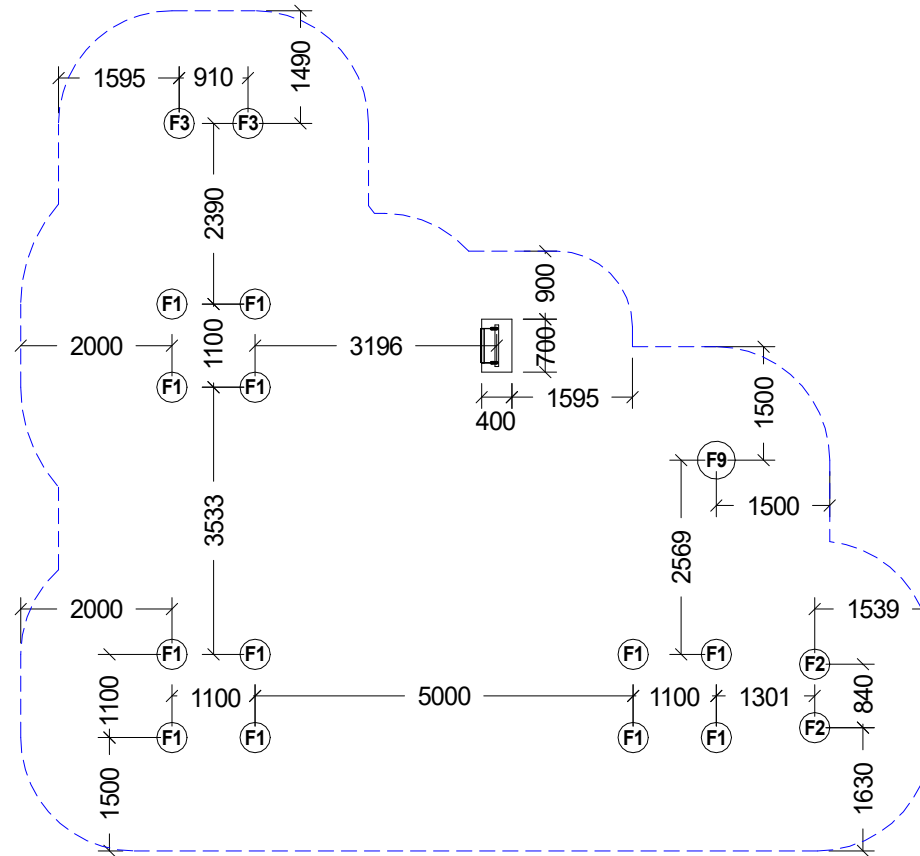
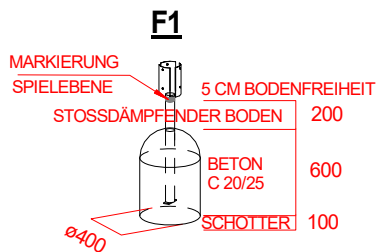
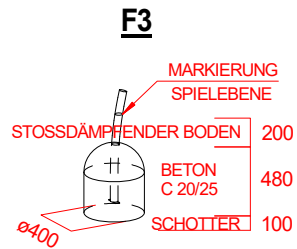
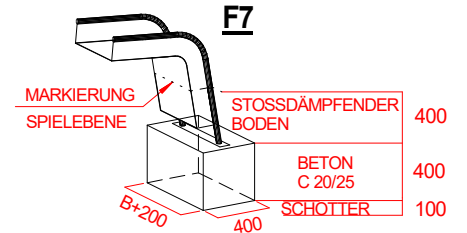
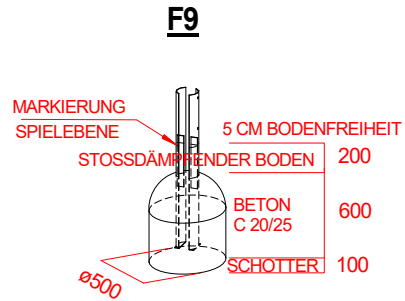

Stoßdämpfender Boden nach DIN 1176  
(Tabelle siehe Wartungsanleitung)



SPK.Distelhausen  
Art.Nr. 31 2030 0078  
Fassung : 01.02.2019  
Konstr. : M. Knoll  
Technische Änderungen vorbehalten

☎ 09342/9649-0 📠 09342/9649-10

Gedruckt am 29.09.2020  
M : 1 = 100 Blatt 3  
gez. :M.Knoll

# Fundament-Plan SH-Bemaßung

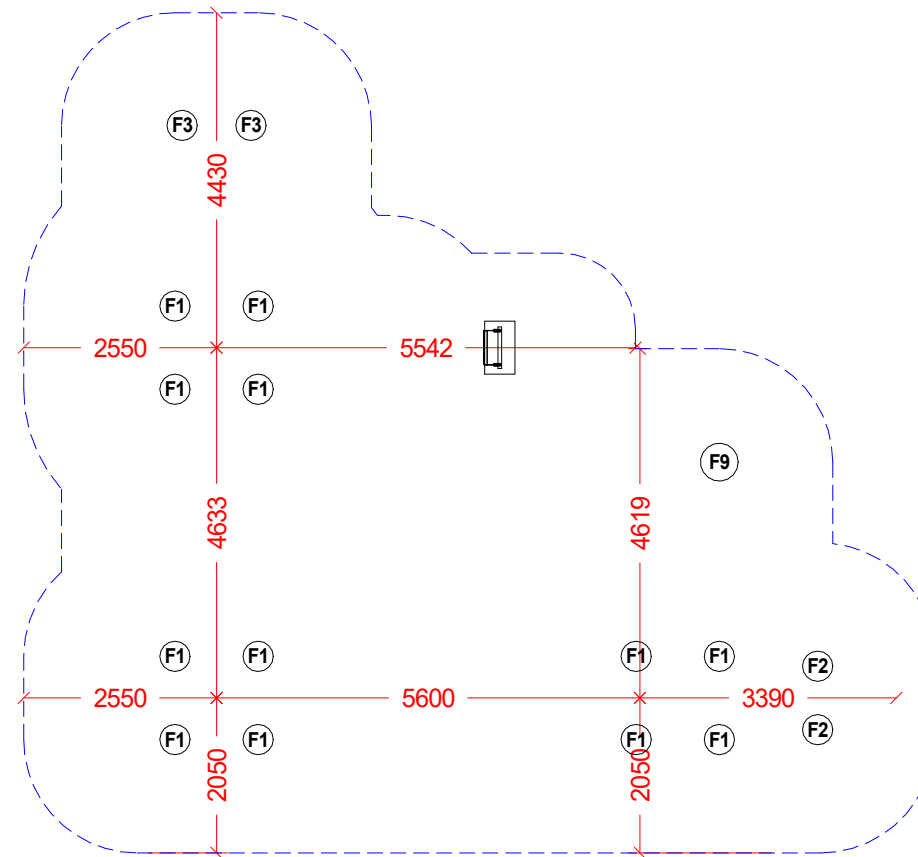
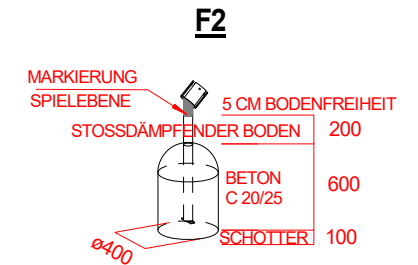
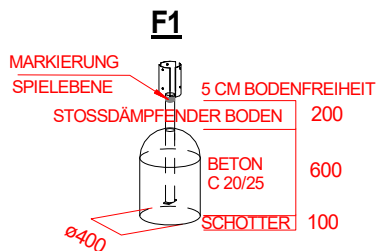
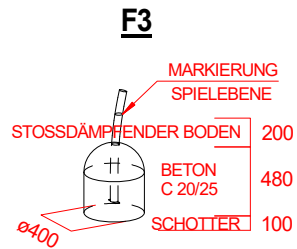
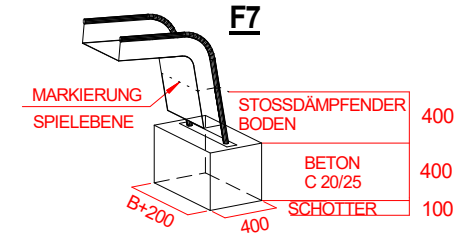
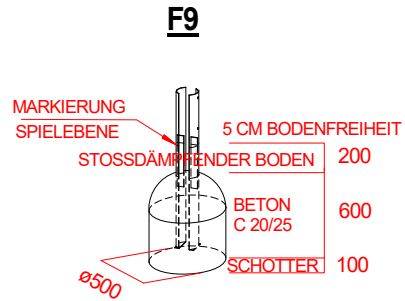

Stoßdämpfender Boden nach DIN 1176  
(Tabelle siehe Wartungsanleitung)



SPK.Distelhausen  
Art.Nr. 31 2030 0078  
G Fassgung : 01.02.2019  
m Konstr. : M. Knoll  
b Technische Änderungen vorbehalten  
h  
☎ 09342/9649-0 📠 09342/9649-10

Gedruckt am 29.09.2020  
M : 1 = 100 Blatt 3  
gez. :M.Knoll

# Pfostenlage Handläufe-Brüstungen Anbaugeräte

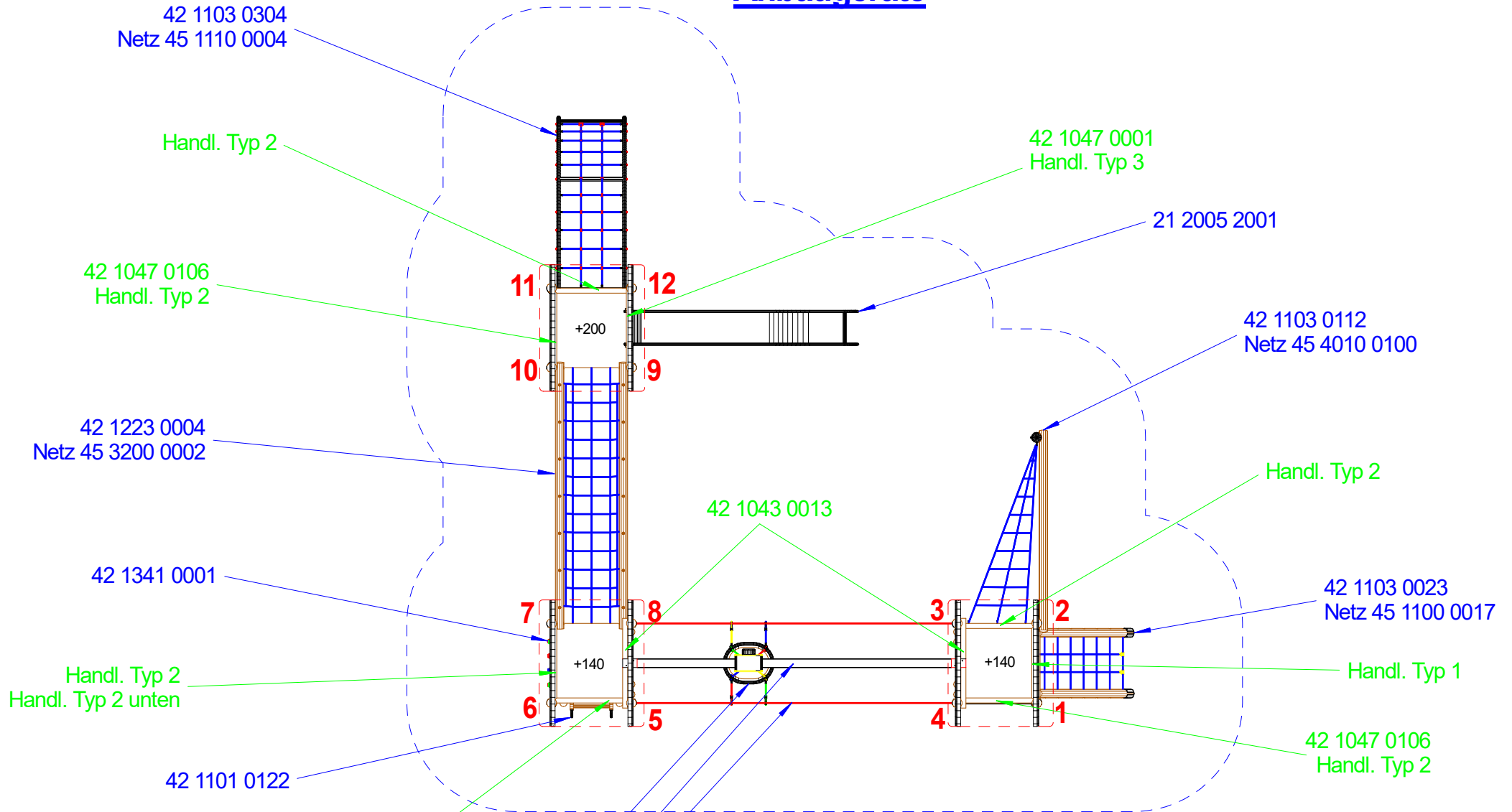

42 1103 0304  
Netz 45 1110 0004

Handl. Typ 2

42 1047 0001  
Handl. Typ 3

21 2005 2001

42 1047 0106  
Handl. Typ 2

42 1103 0112  
Netz 45 4010 0100

42 1223 0004  
Netz 45 3200 0002

Handl. Typ 2

42 1341 0001

42 1043 0013

42 1103 0023  
Netz 45 1100 0017

Handl. Typ 2  
Handl. Typ 2 unten

Handl. Typ 1

42 1101 0122

42 1047 0106  
Handl. Typ 2

42 1043 0024  
Handl. Typ 2  
Handl. Typ 2 unten

42 1241 0000  
40 4512 0002  
45 0300 0000



SPK.Distelhausen  
Art.Nr. 31 2030 0078  
G  
m Fassung : 04.02.2019  
b  
H Konstr. : M. Knoll  
Technische Änderungen vorbehalten

Gedruckt am 29.09.2020  
M : 1 = 75 Blatt 1  
gez. :M.Knoll

☎ 09342/9649-0 📠 09342/9649-10