



Spielkombination "Mayrhofer Straße" - Art.Nr. 31 2020 0407





**G** SPK.Mayrhofer Straße  
**m** Art.Nr. 31 2020 0407  
**b** Fassung : 23.03.2020  
**H** Konstr. : M. Knoll  
Technische Änderungen vorbehalten  
☎ 09342/9649-0 📠 09342/9649-10

Gedruckt am 24.03.2020  
Blatt 0  
gez. :M.Knoll

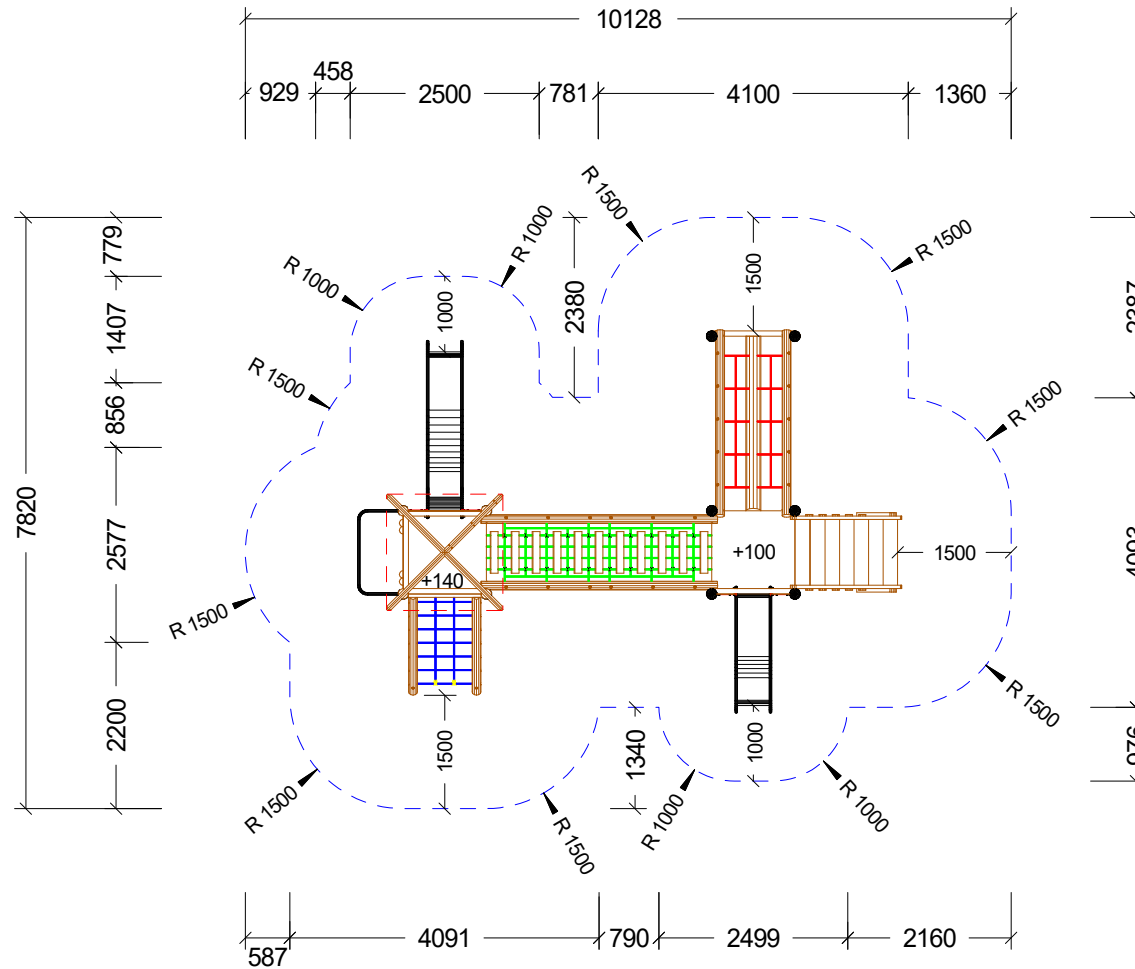

Max. Fallhöhe 1,40 m



**G** SPK.Mayrhofer Straße  
**m** Art.Nr. 31 2020 0407  
**b** Fassung : 23.03.2020  
**H** Konstr. : M. Knoll  
 Technische Änderungen vorbehalten  
 ☎ 09342/9649-0 📠 09342/9649-10

Gedruckt am 24.03.2020  
 M : 1 = 100 Blatt 2  
 gez. :M.Knoll

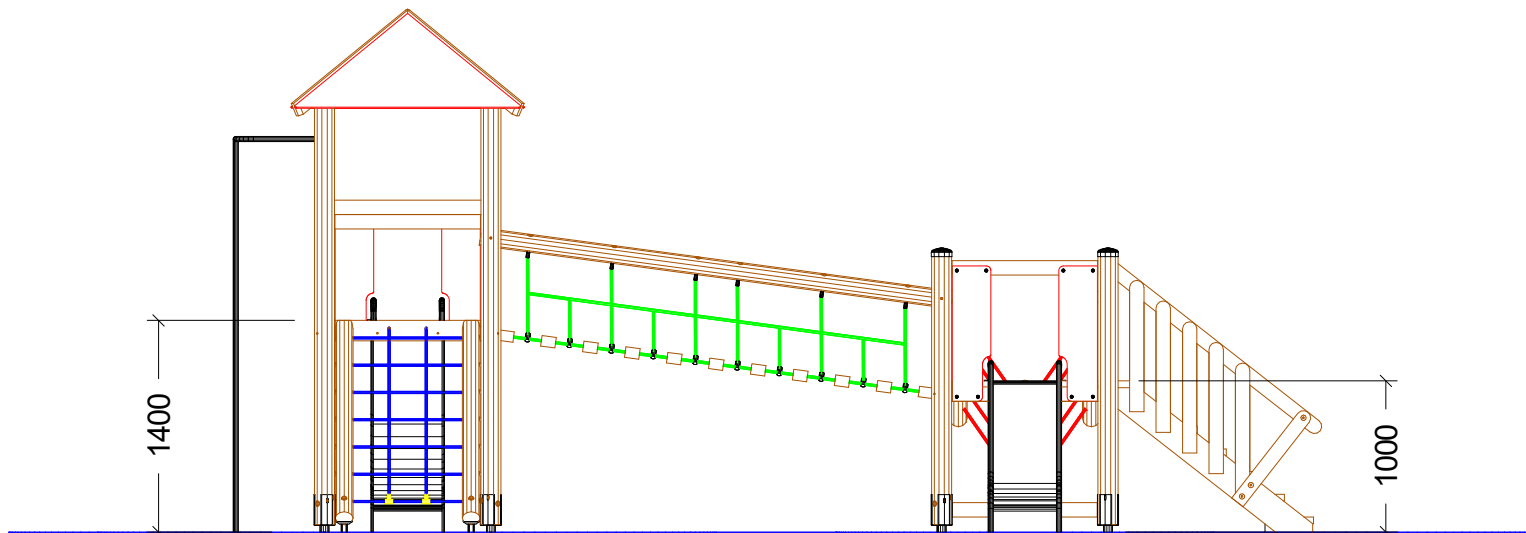
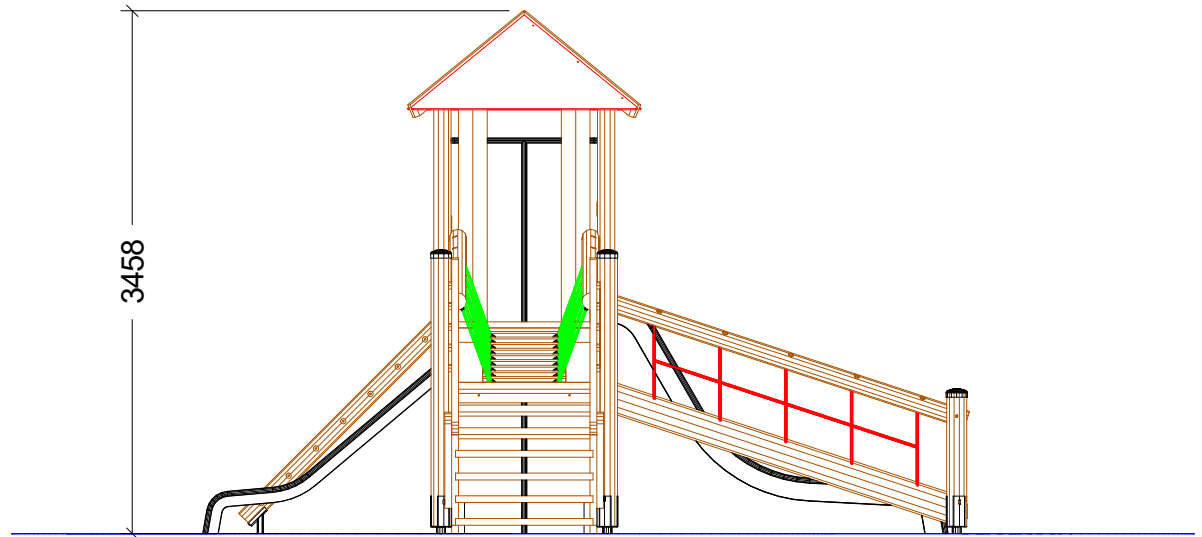

**G** SPK.Mayrhofer Straße  
**m** Art.Nr. 31 2020 0407  
**b** Fassung : 23.03.2020  
**H** Konstr. : M. Knoll  
 Technische Änderungen vorbehalten  
 ☎ 09342/9649-0 📠 09342/9649-10

Gedruckt am 24.03.2020  
 M : 1 = 50 Blatt 1  
 gez. :M.Knoll

# Fundament-Plan

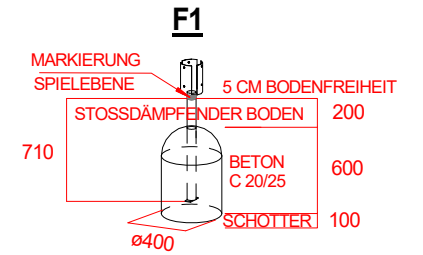
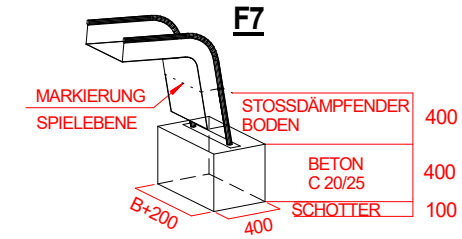

Stoßdämpfender Boden nach DIN 1176  
(Tabelle siehe Wartungsanleitung)

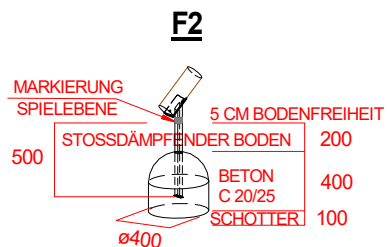
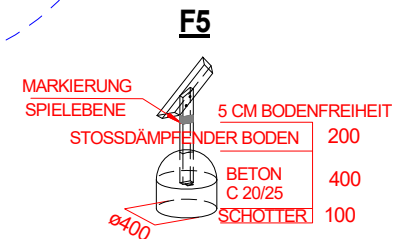
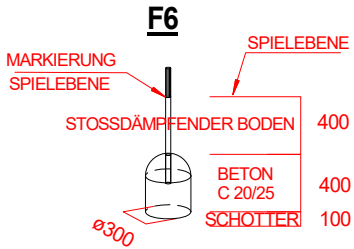
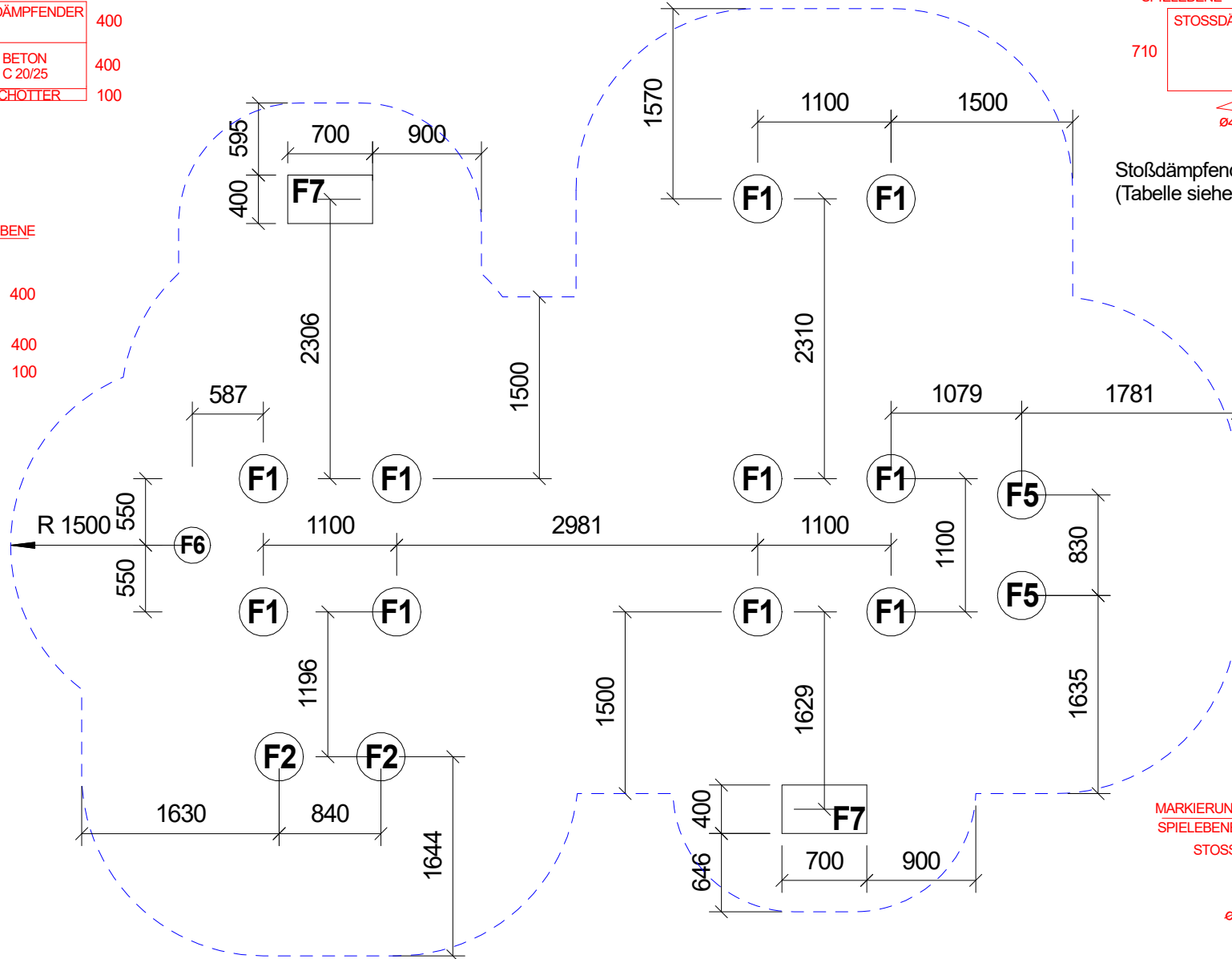

SPK.Mayrhofer Straße  
Art.Nr. 31 2020 0407  
G m b H  
Fassung : 23.03.2020  
Konstr. : M. Knoll  
Technische Änderungen vorbehalten  
☎ 09342/9649-0 📠 09342/9649-10

Gedruckt am 24.03.2020  
M : 1 = 50 Blatt 3  
gez. :M. Knoll

# Fundament-Plan SH-Bemßung

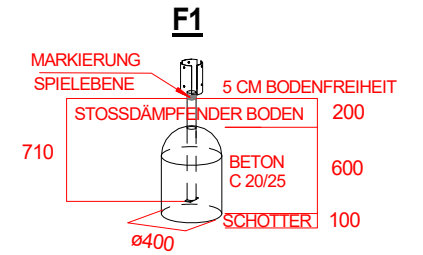
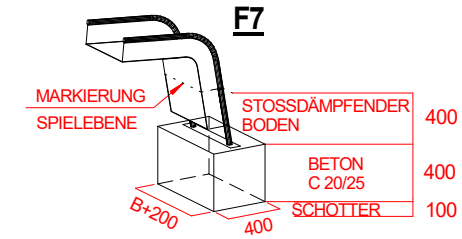

Stoßdämpfender Boden nach DIN 1176  
(Tabelle siehe Wartungsanleitung)

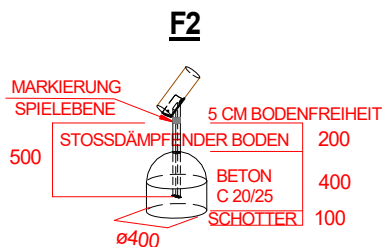
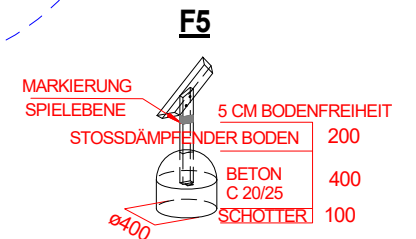
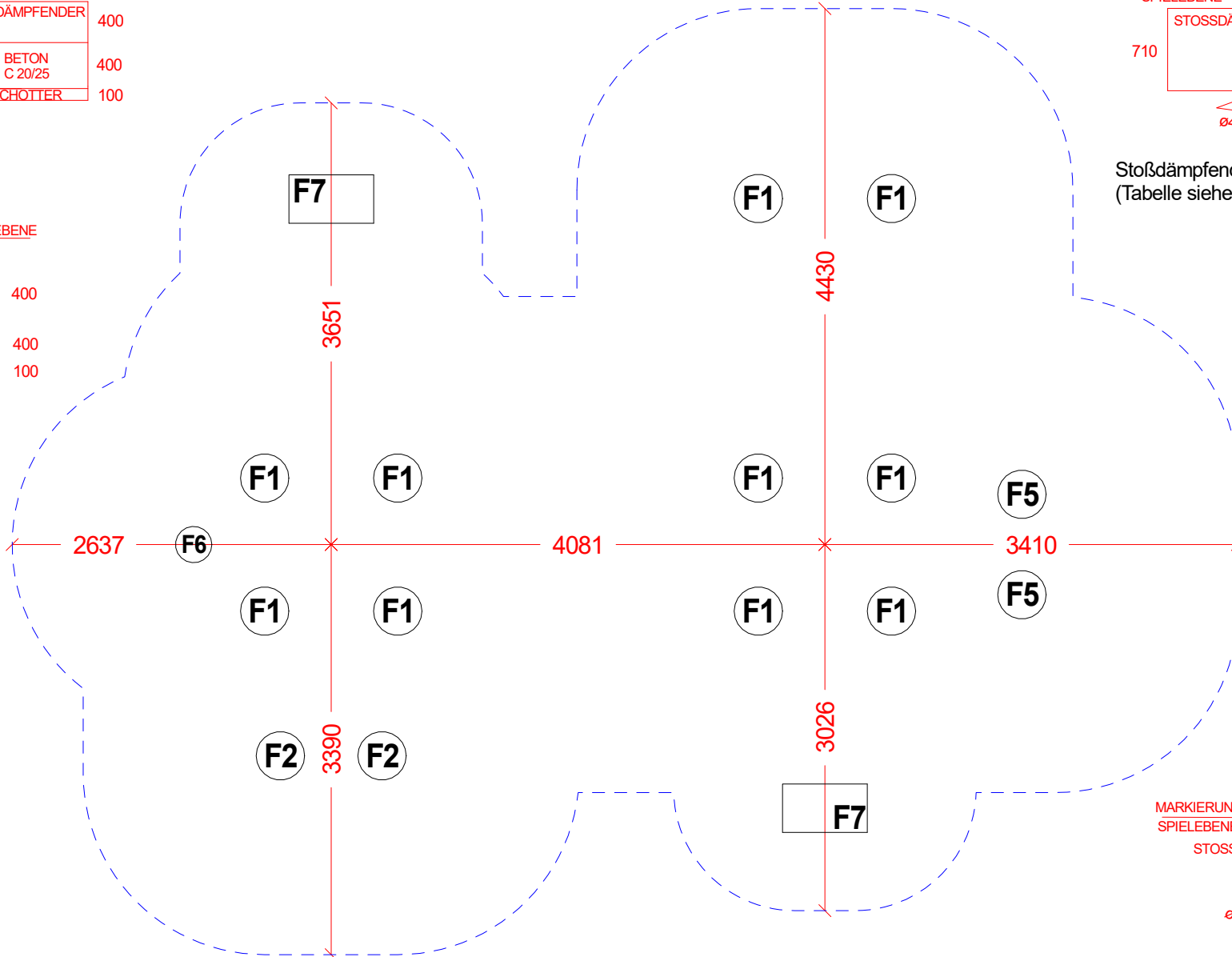
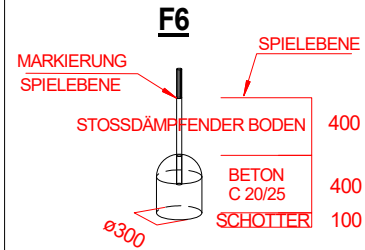

SPK.Mayrhofer Straße  
Art.Nr. 31 2020 0407  
**G** Fassung : 23.03.2020  
**m** Konstr. : M. Knoll  
**b** Technische Änderungen vorbehalten  
**H** ☎ 09342/9649-0 📠 09342/9649-10

Gedruckt am 24.03.2020  
M : 1 = 50 Blatt 3  
gez. :M. Knoll

**Pfostenlage**  
**Handläufe-Brüstungen**  
**Anbaugeräte**

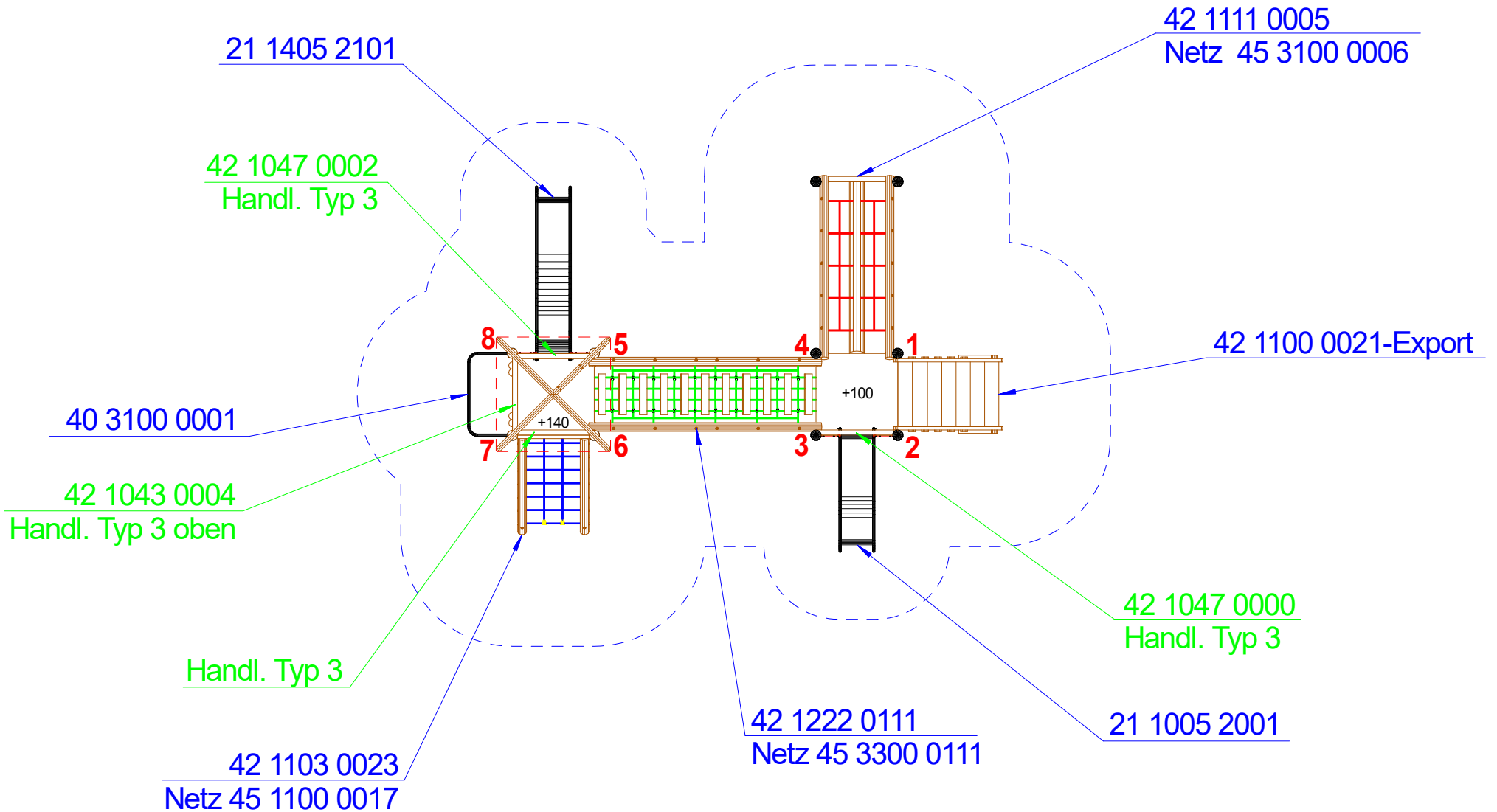

SPK.Mayrhofer Straße  
 Art.Nr. 31 2020 0407  
 G Fassung : 23.03.2020  
 m Konstr. : M. Knoll  
 b Technische Änderungen vorbehalten  
 H  
 ☎ 09342/9649-0 📠 09342/9649-10

Gedruckt am 24.03.2020  
 M : 1 = 75 Blatt 1  
 gez. :M.Knoll